

SOMMAIRE

R3P

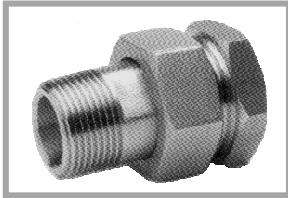

RACCORD UNION ETANCHEITE CONIQUE



R3P...

RACCORD UNION. REDUIT ETANCHEITE CONIQUE

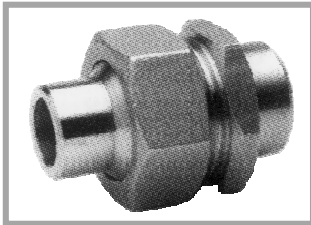

R3P...R

RACCORD UNION. JOINT PLAT

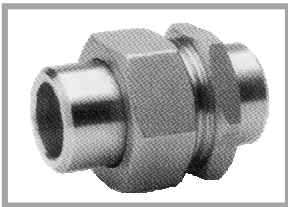

R3P...P

RACCORD UNION. CANNELES JOINT PLAT

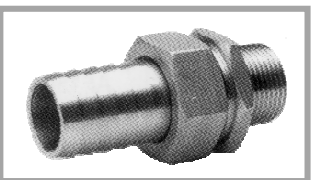

R3P...CP

RACCORD 3 PIECES. SERIE 3000

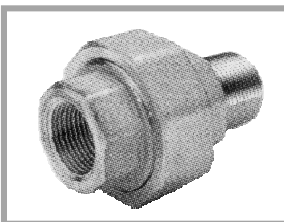

R3PS3...



RACCORD 3 PIECES R3P



Descriptif :

Le raccord 3 pièces est réalisé en Inox 316L [(DIN 17440 – WN 14404) Z2CND 17-12] ou 304L, avec des filetages d'implantation en NPT ou BSP. Ils peuvent être à souder BUTT ou à SOCKET .

Principe de fonctionnement :

Le serrage de l'écrou met en contact les deux autres parties du raccord. L'étanchéité est ainsi assurée par compression des 2 parties coniques du raccord.

Performances :

Ce raccord est de qualité moyenne et par conséquent son utilisation n'est permise qu'au cas où la tuyauterie du système en place est d'un niveau bas de gamme.

Pression maximum : 40 bars

Il existe une gamme supérieure dite 3000 livres et permet une résistance à la pression équivalente à 250 bars.

Qualité :

La qualité d'usinage de ces raccords et du type sanitaire est sans garantie particulière compte tenu du niveau de gamme de ce produit.

Toutefois nous veillons à assurer une fabrication de bonne qualité.

RACCORD UNION

à étanchéité conique

Lisse / lisse 316L
R3P LL

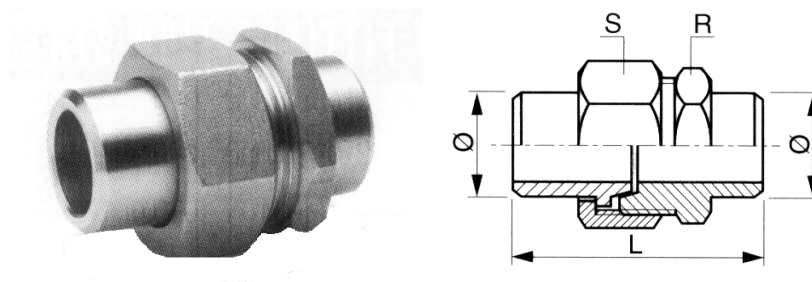

DN	G	Ø	L	R	S	Poids (kg)	Référence
5	1/8"	10.2	40	17	21	0.050	R3PLL5
8	1/4"	13.5	40	17	21	0.050	R3PLL8
12	3/8"	17.2	45	21	24	0.075	R3PLL12
15	1/2"	21.3	48	27	30	0.130	R3PLL15
20	3/4"	26.9	52	36	36	0.195	R3PLL20
25	1"	33.7	55	35*	46	0.325	R3PLL25
32	1"1/4	42.4	56	45*	55	0.420	R3PLL32
40	1"1/2	48.3	58	50*	60	0.485	R3PLL40
50	2"	60.3	62	60*	70	0.710	R3PLL50
65	2"1/2	76.1	81	80*	92	1.250	R3LL65
80	3"	88.9	96	94*	110	1.855	R3PLL80
100	4"	114.3	130	115*	135	4.000	R3PLL100

* 2 plats de serrage

Lisse / femelle 316L

R3P LF

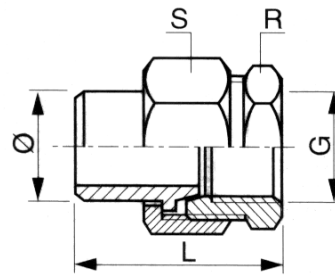
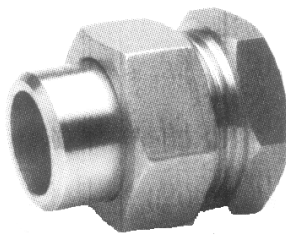

DN	G	Ø	L	R	S	Poids (kg)	Référence GAZ / BSP	Référence NPT / BRIGGS
5	1/8"	10.2	31	17	21	0.045	R3PLF5G	
8	1/4"	13.5	31	17	21	0.040	R3PLF8G	R3PLF8NPT
12	3/8"	17.2	35	21	24	0.060	R3PLF12G	R3PLF12NPT
15	1/2"	21.3	40	27	30	0.105	R3PLF15G	R3PLF15NPT
20	3/4"	26.9	45	36	36	0.170	R3PLF20G	R3PLF20NPT
25	1"	33.7	50	37*	46	0.285	R3PLF25G	R3PLF25NPT
32	1"1/4"	42.4	53	46*	55	0.375	R3PLF32G	R3PLF32NPT
40	1"1/2"	48.3	53	52*	60	0.425	R3PLF40G	R3PLF40NPT
50	2"	60.3	61	63*	70	0.585	R3PLF50G	R3PLF50NPT
65	2"1/2"	76.1	71	80*	92	1.020	R3PLF65G	
80	3"	88.9	84	94*	110	1.635	R3PLF80G	
100	4"	114.3	110	120*	135	3.750	R3PLF100G	

* 2 plats de serrage

Lisse / mâle 316L

R3P LM

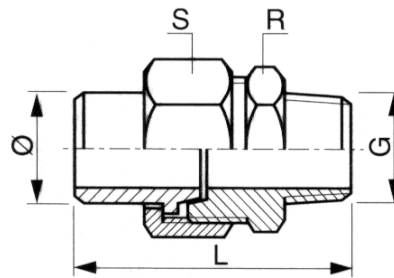
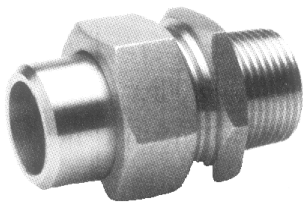

DN	G	Ø	L	R	S	Poids (kg)	Référence GAZ / BSP	Référence NPT / BRIGGS
5	1/8"	10.2	40	17	21	0.050	R3PLM5G	
8	1/4"	13.5	40	17	21	0.050	R3PLM8G	R3PLM8NPT
12	3/8"	17.2	47	21	24	0.075	R3PLM12G	R3PLM12NPT
15	1/2"	21.3	52	27	30	0.130	R3PLM15G	R3PLM15NPT
20	3/4"	26.9	59	36	36	0.205	R3PLM20G	R3PLM20NPT
25	1"	33.7	64	35*	46	0.340	R3PLM25G	R3PLM25NPT
32	1"1/4	42.4	65	45*	55	0.435	R3PLM32G	R3PLM32NPT
40	1"1/2	48.3	65	50*	60	0.480	R3PLM40G	R3PLM40NPT
50	2"	60.3	73	60*	70	0.770	R3PLM50G	R3PLM50NPT
65	2"1/2	76.1	91	80*	92	1.275	R3PLM65G	
80	3"	88.9	108	94*	110	1.915	R3PLM80G	
100	4"	114.3	145	115*	135	4.115	R3PLM100G	

* 2 plats de serrage

Mâle / femelle 316L

R3P MF

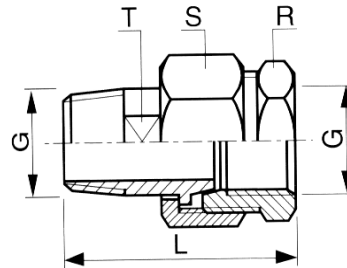
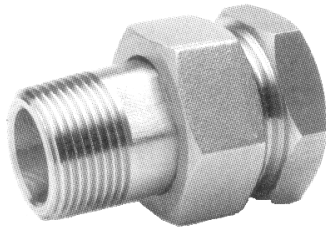

DN	G	L	R	S	T	Poids (kg)	Référence GAZ / BSP	Référence NPT / BRIGGS
5	1/8"	32	17	21	10	0.045	R3PMF5G	
8	1/4"	38	17	21	11	0.040	R3PMF8G	R3PMF8NPT
12	3/8"	42	21	24	14	0.060	R3PMF12G	R3PMF12NPT
15	1/2"	49	27	30	18	0.110	R3PMF15G	R3PMF15NPT
20	3/4"	57	36	36	24	0.190	R3PMF20G	R3PMF20NPT
25	1"	66	37*	46	30	0.315	R3PMF25G	R3PMF25NPT
32	1"1/4	70	46*	55	38	0.420	R3PMF32G	R3PMF32NPT
40	1"1/2	71	52*	60	45	0.470	R3PMF40G	R3PMF40NPT
50	2"	79	63*	70	54	0.695	R3PMF50G	R3PMF50NPT
65	2"1/2	88	80*	92	71	1.125	R3PMF65G	
80	3"	100	94*	110	84	1.715	R3PMF80G	
100	4"	122	120	150	108	3.700	R3PMF100G	

* 2 plats de serrage

Mâle / mâle 316L

R3P MM

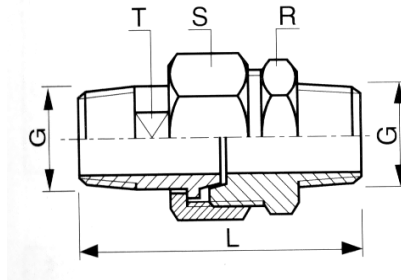
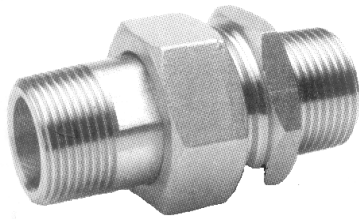

DN	G	L	R	S	T	Poids (kg)	Référence GAZ / BSP	Référence NPT / BRIGGS
5	1/8"	41	17	21	10	0.050	R3PMM5G	
8	1/4"	46	17	21	11	0.050	R3PMM8G	R3PMM8NPT
12	3/8"	53	21	24	14	0.080	R3PMM12G	R3PMM12NPT
15	1/2"	60	27	30	18	0.135	R3PMM15G	R3PMM15NPT
20	3/4"	71	36	36	24	0.225	R3PMM20G	R3PMM20NPT
25	1"	80	35*	46	30	0.370	R3PMM25G	R3PMM25NPT
32	1"1/4	81	45*	55	38	0.480	R3PMM32G	R3PMM32NPT
40	1"1/2	82	50*	60	45	0.530	R3PMM40G	R3PMM40NPT
50	2"	92	60*	70	54	0.875	R3PMM50G	R3PMM50NPT
65	2"1/2	108	80*	92	71	1.360	R3PMM65G	
80	3"	125	94*	110	84	1.995	R3PMM80G	
100	4"	157	115*	135	108	4.300	R3PMM100G	

* 2 plats de serrage

Femelle / femelle 316L

R3P FF

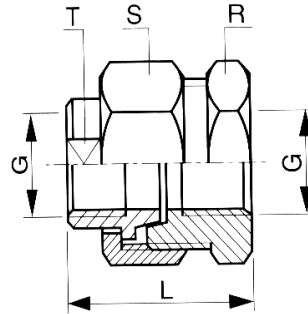
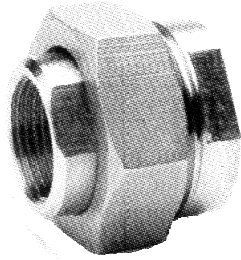

DN	G	L	R	S	T	Poids (kg)	Référence GAZ / BSP	Référence NPT / BRIGGS
5	1/8"	29	21	24	14	0.060	R3PFF5G	
8	1/4"	29	21	24	14	0.060	R3PFF8G	R3PFF8NPT
12	3/8"	34	27	30	18	0.105	R3PFF12G	R3PFF12NPT
15	1/2"	34	36	36	24	0.185	R3PFF15G	R3PFF15NPT
20	3/4"	38	37*	46	30	0.310	R3PFF20G	R3PFF20NPT
25	1"	44	46*	55	38	0.460	R3PFF25G	R3PFF25NPT
32	1"1/4	50	50*	60	45	0.460	R3PFF32G	R3PFF32NPT
40	1"1/2	53	60*	70	54	0.755	R3PFF40G	R3PFF40NPT
50	2"	54	70*	84	63	0.840	R3PFF50G	R3PFF50NPT
65	2"1/2	63	94*	110	83	1.880	R3PFF65G	
80	3"	75	104*	122	94	2.265	R3PFF80G	
100	4"	94	140	150	125	4.055	R3PFF100G	

* 2 plats de serrage

Coudes union femelle femelle 316

R3P CUFF

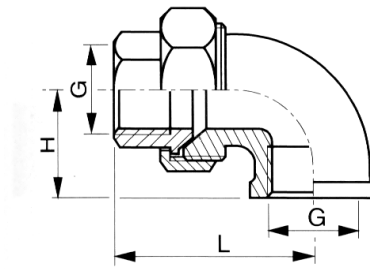
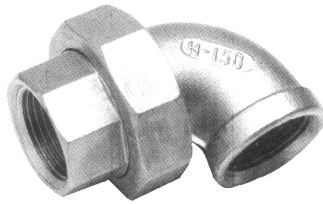

DN	G	L	H	Poids (kg)	Référence GAZ/BSP
8	1/4"	51	35	0.112	R3PCUFF8G
12	3/8"	57	42	0.176	R3PCUFF12G
15	1/2"	67	49	0.222	R3PCUFF15G
20	3/4"	74	58	0.344	R3PCUFF20G
25	1"	90	69	0.530	R3PCUFF25G
32	1"1/4	101	80	0.766	R3PCUFF32G
40	1"1/2	114	90	1.022	R3PCUFF40G
50	2"	133	106	1.604	R3PCUFF50G

Coudes union mâle femelle 316

R3P CUMF

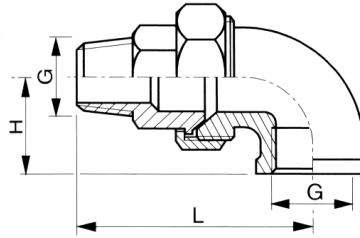
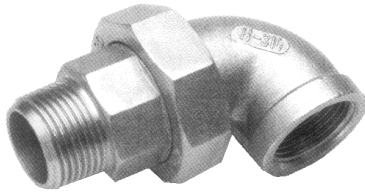

DN	G	L	H	Poids (kg)	Référence GAZ/BSP
8	1/4"	64	35	0.118	R3PCUMF8G
12	3/8"	72	42	0.190	R3PCUMF12G
15	1/2"	82	49	0.244	R3PCUMF15G
20	3/4"	93	58	0.376	R3PCUMF20G
25	1"	111	69	0.572	R3PCUMF25G
32	1"1/4	125	80	0.838	R3PCUMF32G
40	1"1/2	137	90	1.090	R3PCUMF40G
50	2"	161	106	1.732	R3PCUMF50G

RACCORD UNION REDUIT à étanchéité conique - 316L -

Lisse / lisse
R3P LLR

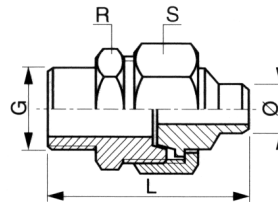
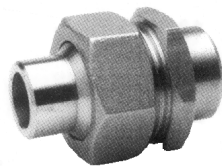

DN	G	Ø	L	R	S	Poids (kg)	Référence
8/5	13.5	10.2	40	17	21	0.050	R3PLLR85
12/8	17.2	13.5	45	21	24	0.075	R3PLLR128
15/12	21.3	17.2	48	27	30	0.130	R3PLLR1512
20/15	26.9	21.3	52	36	36	0.195	R3PLLR2015
25/20	33.7	26.9	55	35*	46	0.325	R3PLLR2520
32/25	42.4	33.7	56	45*	55	0.420	R3PLLR3225
40/32	48.3	42.4	58	50*	60	0.485	R3PLLR4032
50/40	60.3	48.3	62	60*	70	0.710	R3PLLR5040

* 2 plats de serrage

Lisse / femelle

R3P LFR

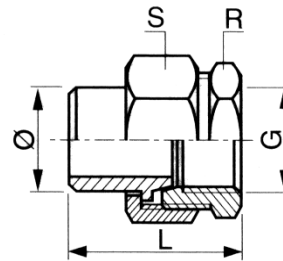
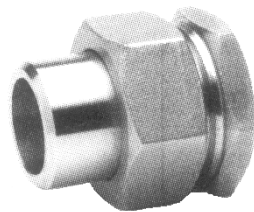

DN	Ø	G	L	R	S	Poids (kg)	Référence Gaz/BSP	Référence NPT/BRIGGS
8/5	13.5	10.2	32	17	21	0.040	R3PLFR85G	R3PLFR85NPT
12/8	17.2	13.5	36	21	24	0.060	R3PLFR128G	R3PLFR128 NPT
15/12	21.3	17.2	40	27	30	0.105	R3PLFR1512G	R3PLFR1512 NPT
20/15	26.9	21.3	46	36	36	0.170	R3PLFR2015G	R3PLFR2015 NPT
25/20	33.7	26.9	46	37*	46	0.285	R3PLFR2520G	R3PLFR2520 NPT
32/25	42.4	33.7	53	46*	55	0.375	R3PLFR3225G	R3PLFR3225 NPT
40/32	48.3	42.4	53	52*	60	0.425	R3PLFR4032G	R3PLFR4032 NPT
50/40	60.3	48.3	56	63*	70	0.585	R3PLFR5040G	R3PLFR5040 NPT

* 2 plats de serrage

Femelle / lisse

R3P FLR

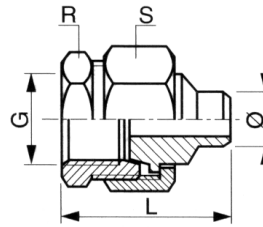
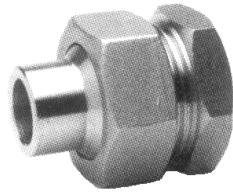

DN	G	Ø	L	R	S	Poids (kg)	Référence Gaz/BSP	Référence NPT/BRIGGS
8/5	1/4"	10.2	32	17	21	0.040	R3PFLR85G	R3PFLR85NPT
12/8	3/8"	13.5	36	21	24	0.060	R3PFLR128G	R3PFLR128NPT
15/12	1/2"	17.2	40	27	30	0.105	R3PFLR1512G	R3PFLR1512NPT
20/15	3/4"	21.3	46	36	36	0.170	R3PFLR2015G	R3PFLR2015NPT
25/20	1"	26.9	46	37*	46	0.285	R3PFLR2520G	R3PFLR2520NPT
32/25	1"1/4	33.7	50	46*	55	0.375	R3PFLR3225G	R3PFLR3225NPT
40/32	1"1/2	42.4	53	52*	60	0.425	R3PFLR4032G	R3PFLR4032NPT
50/40	2"	48.3	56	63*	70	0.585	R3PFLR5040G	R3PFLR5040NPT

* 2 plats de serrage

Lisse / mâle
R3P LMR

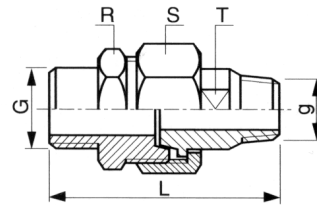
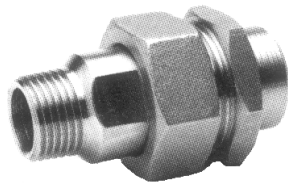

DN	G	g	L	R	S	T	Poids (kg)	Référence Gaz/BSP	Référence NPT/BRIGGS
8/5	1/4"	1/8"	46	17	21	11	0.050	R3PLMR85G	R3PLMR85NPT
12/8	3/8"	1/4"	51	21	24	14	0.075	R3PLMR128G	R3PLMR128NPT
15/12	1/2"	3/8"	57	27	30	18	0.130	R3PLMR1512G	R3PLMR1512NPT
20/15	3/4"	1/2"	63	36	36	24	0.205	R3PLMR2015G	R3PLMR2015NPT
25/20	1"	3/4"	75	37*	46	30	0.340	R3PLMR2520G	R3PLMR2520NPT
32/25	1"1/4	1"	76	46*	55	38	0.435	R3PLMR3225G	R3PLMR3225NPT
40/32	1"1/2	1"1/4	76	52*	60	45	0.480	R3PLMR4032G	R3PLMR4032NPT
50/40	2"	1"1/2	85	63*	70	54	0.770	R3PLMR5040G	R3PLMR5040NPT

* 2 plats de serrage

Mâle / lisse

R3P MLR

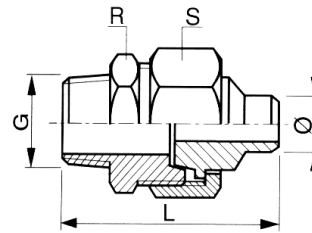
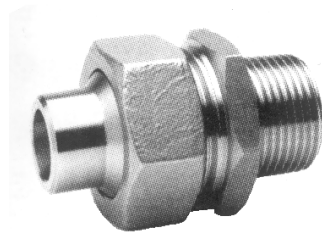

DN	G	Ø	L	R	S	Poids (kg)	Référence Gaz/BSP	Référence NPT/BRIGGS
8/5	1/4"	10.2	40	17	21	0.050	R3PMLR85G	R3PMLR85NPT
12/8	3/8"	13.5	47	21	24	0.075	R3PMLR128G	R3PMLR128NPT
15/12	1/2"	17.2	52	27	30	0.130	R3PMLR1512G	R3PMLR1512NPT
20/15	3/4"	21.3	59	36	36	0.205	R3PMLR2015G	R3PMLR2015NPT
25/20	1"	26.9	64	35*	46	0.340	R3PMLR2520G	R3PMLR2520NPT
32/25	1"1/4"	33.7	65	45*	55	0.435	R3PMLR3225G	R3PMLR3225NPT
40/32	1"1/2"	42.4	65	50*	60	0.480	R3PMLR4032G	R3PMLR4032NPT
50/40	2"	48.3	73	60*	70	0.770	R3PMLR5040G	R3PMLR5040NPT

* 2 plats de serrage

Mâle / femelle

R3P MFR

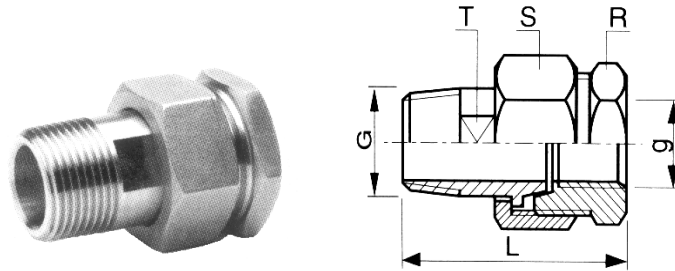

DN	G	g	L	R	S	T	Poids (kg)	Référence Gaz/BSP
8/5	1/4"	1/8	38	17	21	11	0.040	R3PMFR85G
12/8	3/8"	1/4	42	21	24	14	0.060	R3PMFR128G
15/12	1/2"	3/8	49	27	30	18	0.110	R3PMFR1512G
20/15	3/4"	1/2	57	36	36	24	0.190	R3PMFR2015G
25/20	1"	3/4	66	37*	46	30	0.315	R3PMFR2520G
32/25	1"1/4	1"	70	46*	55	38	0.420	R3PMFR3225G
40/32	1"1/2	1"1/4	71	52*	60	45	0.470	R3PMFR4032G
50/40	2"	1"1/2	79	63*	70	54	0.695	R3PMFR5040G

* 2 plats de serrage

Femelle / mâle

R3P FMR

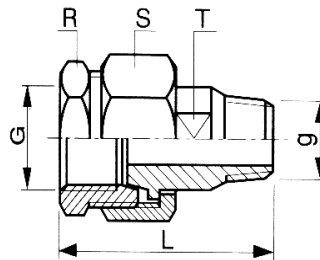
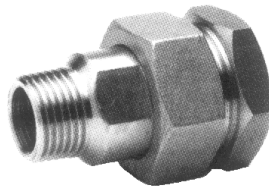

DN	G	g	L	R	S	T	Poids (kg)	Référence Gaz/BSP
8/5	1/4"	1/8"	38	17	21	11	0.040	R3PFMR85G
12/8	3/8"	1/4"	42	21	24	14	0.060	R3PFMR128G
15/12	1/2"	3/8"	49	27	30	18	0.110	R3PFMR1512G
20/15	3/4"	1/2"	57	36	36	24	0.190	R3PFMR2015G
25/20	1"	3/4"	66	37*	46	30	0.315	R3PFMR2520G
32/25	1"1/4	1"	70	46*	55	38	0.420	R3PFMR3225G
40/32	1"1/2	1"1/4	71	52*	60	45	0.470	R3PFMR4032G
50/40	2"	1"1/2	79	63*	70	54	0.695	R3PFMR5040G

* 2 plats de serrage

Mâle / mâle

R3P MMR

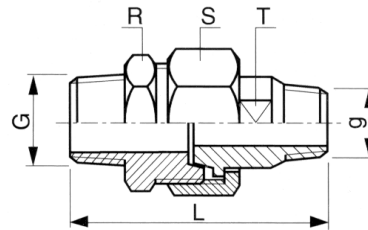
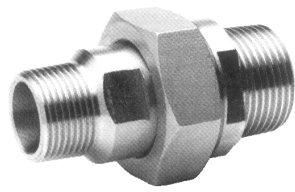

DN	G	g	L	R	S	T	Poids (kg)	Référence Gaz/BSP
8/5	1/4"	1/8"	46	17	21	11	0.050	R3PMMR85G
12/8	3/8"	1/4"	53	21	24	14	0.080	R3PMMR128G
15/12	1/2"	3/8"	60	27	30	18	0.135	R3PMMR1512G
20/15	3/4"	1/2"	71	36	36	24	0.225	R3PMMR2015G
25/20	1"	3/4"	80	35*	46	30	0.370	R3PMMR2520G
32/25	1"1/4	1"	81	45*	55	38	0.480	R3PMMR3225G
40/32	1"1/2	1"1/4	82	50*	60	45	0.530	R3PMMR4032G
50/40	2"	1"1/2	92	60*	70	54	0.875	R3PMMR5040G

* 2 plats de serrage

Femelle / femelle

R3P FFR

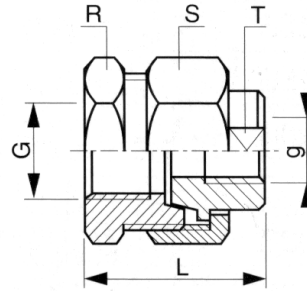
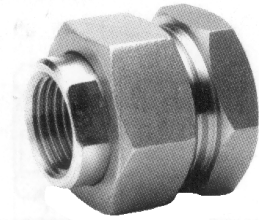

DN	G	g	L	R	S	T	Poids (kg)	Référence Gaz/BSP	Référence NPT/BRIGGS
12/8	3/8"	1/4	30	21	24	14	0.050	R3PFFR128G	R3PFFR128NPT
15/12	1/2"	3/8	34	27	30	18	0.095	R3PFFR1512G	R3PFFR1512NPT
20/15	3/4"	1/2	37	36	36	24	0.160	R3PFFR2015G	R3PFFR2015NPT
25/20	1"	3/4	47	37*	46	30	0.270	R3PFFR2520G	R3PFFR2520NPT
32/25	1"1/4	1"	50	46*	55	38	0.380	R3PFFR3225G	R3PFFR3225NPT
40/32	1"1/2	1"1/4	53	52*	60	45	0.390	R3PFFR4032G	R3PFFR4032NPT
50/40	2"	1"1/2	56	63*	70	54	0.580	R3PFFR5040G	R3PFFR5040NPT

* 2 plats de serrage

RACCORD UNION à joint plat

Jointes pour raccords union à joint plat Téflon ou Viton

R3P JTRU/ R3P JVRU



DN	D	d	e	Référence TEFLON	Référence VITON
8	15	10	1.5	R3PJTRU8	R3PJVRU8
12	19	14	1.5	R3PJTRU12	R3PJVRU12
15	24	17	2	R3PJTRU15	R3PJVRU15
20	30	22	2	R3PJTRU20	R3PJVRU20
25	38	29	2	R3PJTRU25	R3PJVRU25
32	47	37	2	R3PJTRU32	R3PJVRU32
40	53	43	3	R3PJTRU40	R3PJVRU40
50	62	52	3	R3PJTRU50	R3PJVRU50

Lisse / lisse 316L

R3P LLP

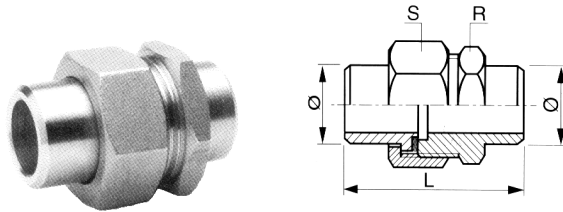

DN	Ø	L	R	S	Poids (kg)	Référence GAZ/BSP
8	13.5	40	17	21	0.050	R3PLLP8
12	17.2	45	21	24	0.075	R3PLLP12
15	21.3	48	27	30	0.130	R3PLLP15
20	26.9	52	36	36	0.195	R3PLLP20
25	33.7	55	35*	46	0.325	R3PLLP25
32	42.4	56	45*	55	0.420	R3PLLP32
40	48.3	58	50*	60	0.490	R3PLLP40
50	60.3	62	60*	70	0.710	R3PLLP50
65	76.1	81	80*	92	1.250	R3PLLP65
80	88.9	130	115*	135	1.855	R3PLLP80

* 2 plats de serrage

Lisse / femelle 316L

R3P LFP

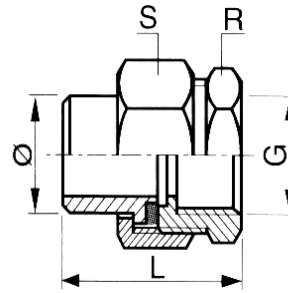
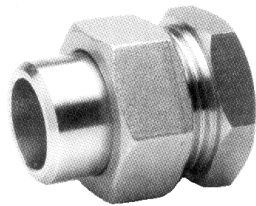

DN	G	Ø	L	R	S	Poids (kg)	Référence GAZ/BSP
8	1/4"	13.5	31	17	21	0.040	R3PLFP8G
12	3/8"	17.2	35	21	24	0.060	R3PLFP12G
15	1/2"	21.3	40	27	30	0.105	R3PLFP15G
20	3/4"	26.9	45	36	36	0.170	R3PLFP20G
25	1"	33.7	50	37*	46	0.285	R3PLFP25G
32	1"1/4	42.4	53	46*	55	0.375	R3PLFP32G
40	1"1/2	48.3	53	52*	60	0.425	R3PLFP40G
50	2"	60.3	61	63*	70	0.585	R3PLFP50G
65	2"1/2	76.1	71	80*	92	1.020	R3PLFP65G
80	3"	88.9	84	94*	110	1.635	R3PLFP80G

* 2 plats de serrage

Lisse / mâle 316L

R3P LMP

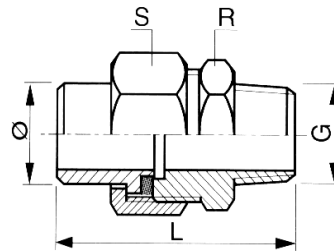

DN	G	Ø	L	R	S	Poids (kg)	Référence GAZ/BSP
8	1/4"	13.5	40	17	21	0.050	R3PLMP8G
12	3/8"	17.2	47	21	24	0.075	R3PLMP12G
15	1/2"	21.3	52	27	30	0.130	R3PLMP15G
20	3/4"	26.9	59	36	36	0.205	R3PLMP20G
25	1"	33.7	64	35*	46	0.340	R3PLMP25G
32	1"1/4	42.4	65	45*	55	0.435	R3PLMP32G
40	1"1/2	48.3	65	50*	60	0.480	R3PLMP40G
50	2"	60.3	73	60*	70	0.770	R3PLMP50G
65	2"1/2	76.1	91	80*	92	1.280	R3PLMP65G
80	3"	88.9	108	94*	110	1.915	R3PLMP80G

* 2 plats de serrage

Mâle / femelle 316L

R3P MFP

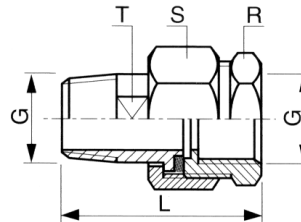
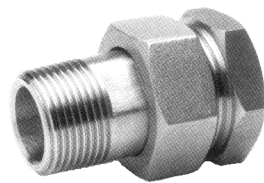

DN	G	L	R	S	T	Poids (kg)	Référence GAZ/BSP
8	1/4"	38	17	21	11	0.040	R3PMFP8G
12	3/8"	42	21	24	14	0.060	R3PMFP12G
15	1/2"	49	27	30	18	0.110	R3PMFP15G
20	3/4"	57	36	36	24	0.190	R3PMFP20G
25	1"	66	37*	46	30	0.315	R3PMFP25G
32	1"1/4	70	46*	55	38	0.420	R3PMFP32G
40	1"1/2	71	52*	60	45	0.470	R3PMFP40G
50	2"	79	63*	70	54	0.695	R3PMFP50G
65	2"1/2	88	80*	92	71	1.125	R3PMFP65G
80	3"	100	94*	110	84	1.715	R3PMFP80G

* 2 plats de serrage

Mâle / mâle 316L

R3P MMP

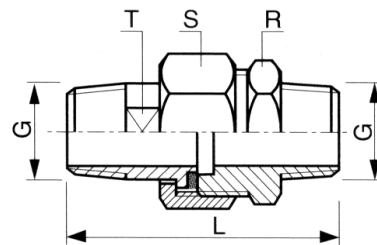
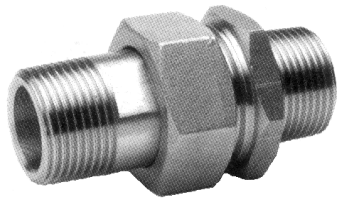

DN	G	L	R	S	T	Poids (kg)	Référence GAZ/BSP
8	1/4"	46	17	21	11	0.052	R3PMMP8G
12	3/8"	53	21	24	14	0.080	R3PMMP12G
15	1/2"	60	27	30	18	0.135	R3PMMP15G
20	3/4"	71	36	36	24	0.225	R3PMMP20G
25	1"	80	35*	46	30	0.370	R3PMMP25G
32	1"1/4	81	45*	55	38	0.480	R3PMMP32G
40	1"1/2	82	50*	60	45	0.530	R3PMMP40G
50	2"	92	60*	70	54	0.875	R3PMMP50G
65	2"1/2	108	80*	92	71	1.360	R3PMMP65G
80	3"	125	94*	110	84	1.995	R3PMMP80G

* 2 plats de serrage

Femelle/ femelle 316L

R3P FFP

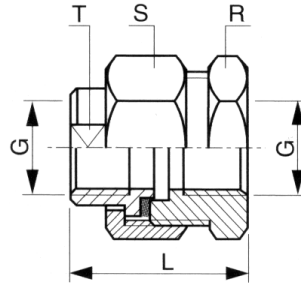
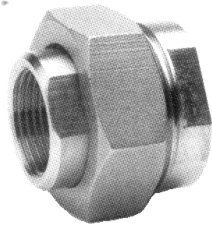

DN	G	L	R	S	T	Poids (kg)	Référence GAZ/BSP
8	1/4"	29	21	24	14	0.060	R3PFFP8G
12	3/8"	34	27	30	18	0.105	R3PFFP12G
15	1/2"	34	36	36	24	0.185	R3PFFP15G
20	3/4"	38	37*	46	30	0.310	R3PFFP20G
25	1"	44	46*	55	38	0.460	R3PFFP25G
32	1"1/4	50	50*	60	45	0.460	R3PFFP32G
40	1"1/2	53	60*	70	54	0.755	R3PFFP40G
50	2"	54	70*	84	63	0.840	R3PFFP50G
65	2"1/2	63	94*	110	83	1.880	R3PFFP65G
80	3"	75	104*	122	94	2.265	R3PFFP80G

* 2 plats de serrage

RACCORD UNION

Cannelé à joint plat -316L-

Lisse cannelé
R3P LCP

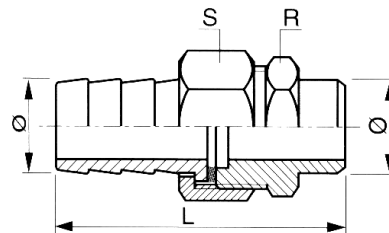
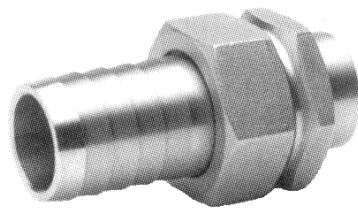

DN	Ø	L	R	S	Poids (kg)	Référence
8	13.5	46	17	21	0.055	R3PLCP8
12	17.2	52	21	24	0.080	R3PLCP12
15	21.3	59	27	30	0.150	R3PLCP15
20	26.9	67	36	36	0.220	R3PLCP20
25	33.7	75	35*	46	0.380	R3PLCP25
32	42.4	79	45*	55	0.500	R3PLCP32
40	48.3	77	50*	60	0.560	R3PLCP40
50	60.3	88	60*	70	0.900	R3PLCP50

* 2 plats de serrage

Mâle cannelé

R3P MCP

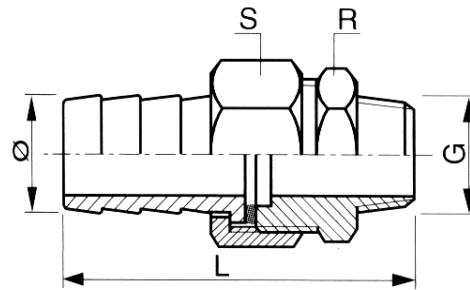
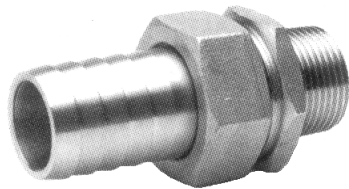

DN	G	Ø	L	R	S	Poids (kg)	Référence GAZ/BSP
8	1/4"	13.5	46	17	21	0.055	R3PMCP8G
12	3/8"	17.2	53	21	24	0.080	R3PMCP12G
15	1/2"	21.3	63	27	30	0.155	R3PMCP15G
20	3/4"	26.9	74	36	36	0.220	R3PMCP20G
25	1"	33.7	84	35*	46	0.390	R3PMCP25G
32	1"1/4	42.4	88	45*	55	0.525	R3PMCP32G
40	1"1/2	48.3	84	50*	60	0.550	R3PMCP40G
50	2"	60.3	100	60*	70	0.950	R3PMCP50G

* 2 plats de serrage

Femelle cannelé

R3P FCP

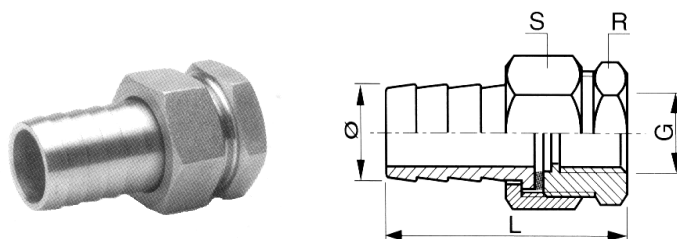

DN	G	Ø	L	R	S	Poids (kg)	Référence GAZ/BSP
8	1/4"	13.5	37	17	21	0.050	R3PFCP8G
12	3/8"	17.2	41	21	24	0.065	R3PFCP12G
15	1/2"	21.3	51	27	30	0.125	R3PFCP15G
20	3/4"	26.9	60	36	36	0.210	R3PFCP20G
25	1"	33.7	70	37*	46	0.335	R3PFCP25G
32	1"1/4	42.4	76	46*	55	0.460	R3PFCP32G
40	1"1/2	48.3	72	52*	60	0.490	R3PFCP40G
50	2"	60.3	87	63*	70	0.780	R3PFCP50G

* 2 plats de serrage

Ecrous tournants

R3P ET

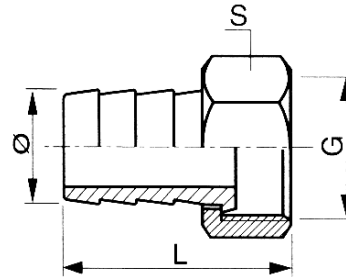
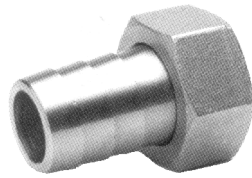

DN	G	Ø	L	S	Poids (kg)	Référence
12	3/8"	13.5	31.5	21	0.040	R3PET12G
15	1/2"	17.2	37.5	24	0.045	R3PET15G
20	3/4"	21.3	44	30	0.080	R3PET20G
25	1"	26.9	50.5	36	0.130	R3PET25G
32	1"1/4	33.7	56.5	46	0.215	R3PET32G
40	1"1/2	42.4	62	55	0.330	R3PET40G
50	2"	48.3	62	65	0.370	R3PET50G
65	2"1/2	60.3	68	84	0.630	R3PET65G

SERIE 3000

RACCORD UNION

Extrémités filetées – 304L et 316L – à étanchéité conique

Unions femelle / femelle taraudées NPT
R3P S3 2FF/ R3P S3 4FF

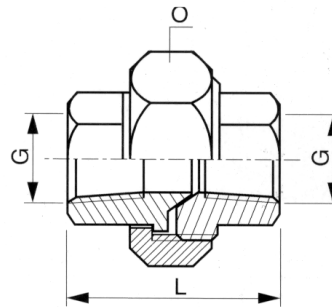
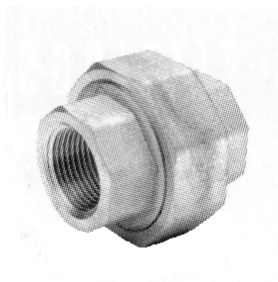

DN	G	L	O	Poids (kg)	Référence 304L	Référence 316L
8	1/4"	42.5	36	0.180	R3PS32FF8	R3PS34FF8
12	3/8"	47.5	47	0.330	R3PS32FF12	R3PS34FF12
15	1/2"	52	47	0.360	R3PS32FF15	R3PS34FF15
20	3/4"	57	56	0.540	R3PS32FF20	R3PS34FF20
25	1"	63	65	0.765	R3PS32FF25	R3PS34FF25
32	1"1/4	70	78	0.975	R3PS32FF32	R3PS34FF32
40	1"1/2	78	86	1.545	R3PS32FF40	R3PS34FF40
50	2"	89	103	2.150	R3PS32FF50	R3PS34FF50

Unions mâle femelle NPT

R3P S3 2MF

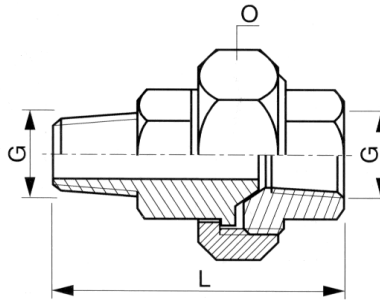
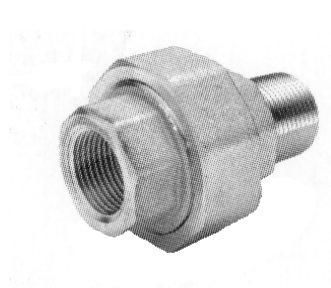

DN	G	L	O	Poids (kg)	Référence 304L	Référence 316L
8	1/4"	63	36	0.210	R3PS32MF8	R3PS34MF8
12	3/8"	69	47	0.440	R3PS32MF12	R3PS34MF12
15	1/2"	77	47	0.450	R3PS32MF15	R3PS34MF15
20	3/4"	80	56	0.610	R3PS32MF20	R3PS34MF20
25	1"	97	65	0.945	R3PS32MF25	R3PS34MF25
32	1"1/4	101	78	1.200	R3PS32MF32	R3PS34MF32
40	1"1/2	110	86	1.900	R3PS32MF40	R3PS34MF40
50	2"	120	103	2.700	R3PS32MF50	R3PS34MF50

SERIE 3000

Extrémités à souder Socket Welded -304L et 316L- à étanchéité conique

Union femelle / femelle SW

R3P S3 2FFW

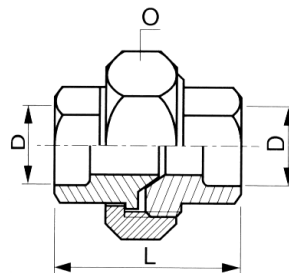

DN	D	L	O	Poids (kg)	Référence 304L	Référence 316L
8	1/4"	42.5	36	0.175	R3PS32FFW8	R3PS34FFW8
12	3/8"	47.5	47	0.350	R3PS32FFW12	R3PS34FFW12
15	1/2"	52	47	0.305	R3PS32FFW15	R3PS34FFW15
20	3/4"	57	56	0.525	R3PS32FFW20	R3PS34FFW20
25	1"	63	65	0.730	R3PS32FFW25	R3PS34FFW25
32	1"1/4	70	78	1.235	R3PS32FFW32	R3PS34FFW32
40	1"1/2	78	86	1.490	R3PS32FFW40	R3PS34FFW40
50	2"	89	103	2.415	R3PS32FFW50	R3PS34FFW50

SERIE 3000
RACCORD UNION
à joint plat -316L-

Joints pour raccords union métalloplastique
R3P S3 JMRU

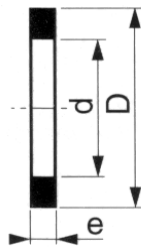

DN	D	d	e	Référence METAL
8				R3PS3JMRU8
15				R3PS3JMRU15

SW / SW
R3P S3 SWSWP

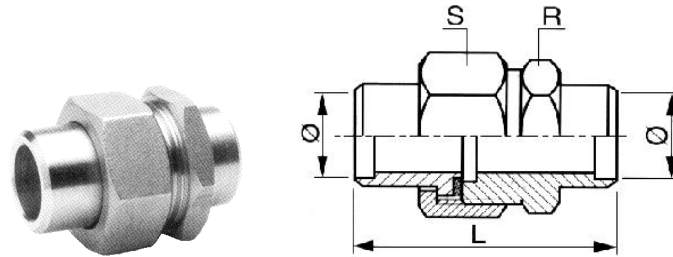

DN	Ø	L	R	S	Référence
8	13,7	58	27	27	R3PS3SWSWP8
15	21,3	66	36	36	R3PS3SWSWP15

SW / femelle
R3P S3 SWFP

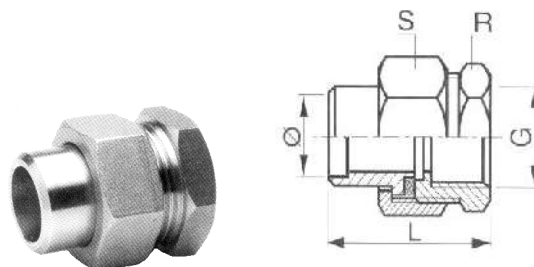

DN	G	Ø	L	R	S	Référence NPT/BRIGGS
8	1/4"	13,7	58	27	27	R3PS3SWFP8NPT
12	3/8"	17,2	66	36	36	R3PS3SWFP12NPT
15	1/2"	21,3	66	36	36	R3PS3SWFP15NPT

SW / mâle
R3P S3 SWMP

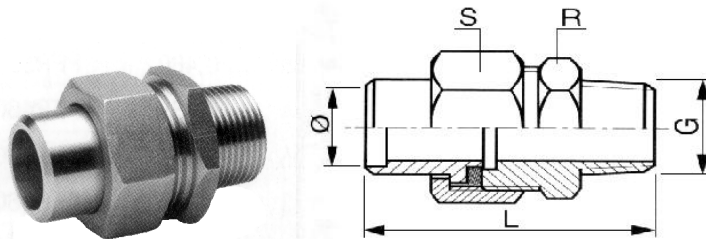

DN	G	Ø	L	R	S	Référence NPT/BRIGGS
8	1/4"	13,7	58	27	27	R3PS3SWMP8NPT
15	1/2"	21,3	66	36	36	R3PS3SWMP15NPT

Mâle / femelle
R3P S3 MFP

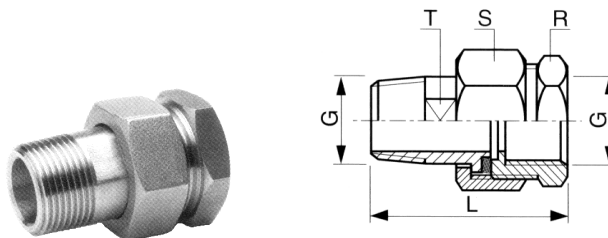

DN	G	L	R	S	T	Référence NPT/BRIGGS
8	1/4"	58	27	27	15	R3PS3MFP8NPT
15	1/2"	66	36	36	23	R3PS3MFP15NPT

Mâle / mâle
R3P S3 MMP

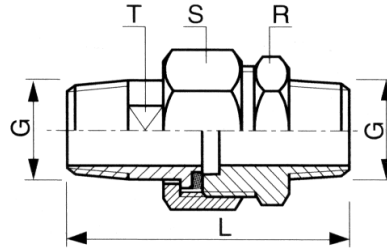
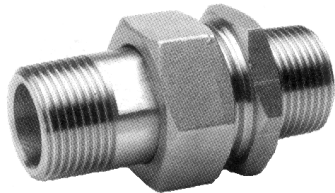

DN	G	L	R	S	T	Référence NPT/BRIGGS
8	1/4"	65	27	27	15	R3PS3MMP8NPT
15	1/2"	76	36	36	23	R3PS3MMP15NPT

Femelle / femelle
R3P S3 FFP

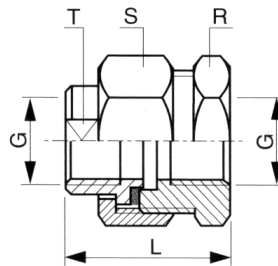

DN	G	L	R	S	T	Référence NPT/BRIGGS
8	1/4"	58	27	27	15	R3PS3FFP8NPT
15	1/2"	66	36	36	23	R3PS3FFP15NPT

